

**Parts**

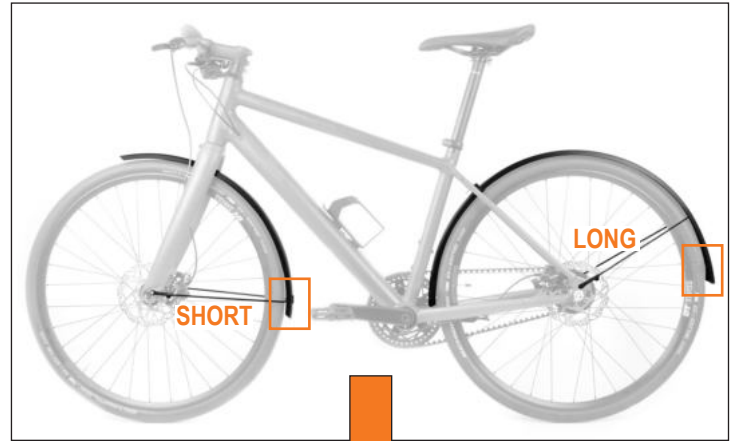

**1. Stay-assembling front + rear**

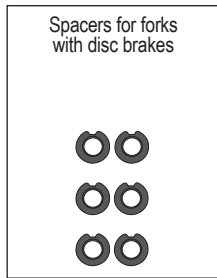
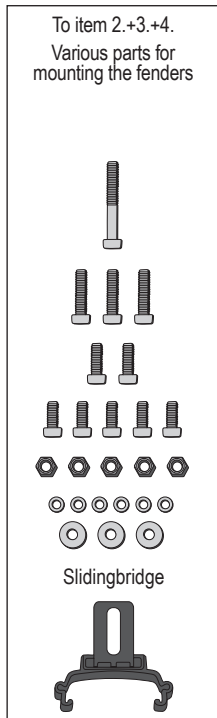
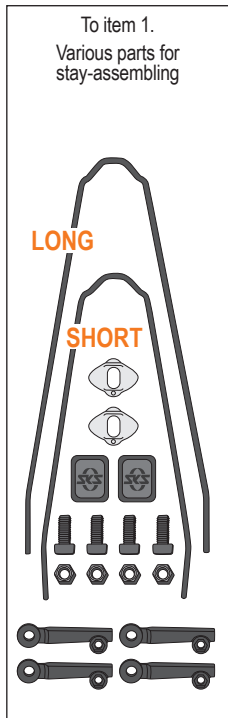
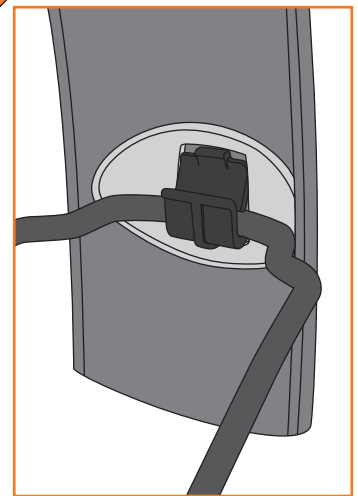
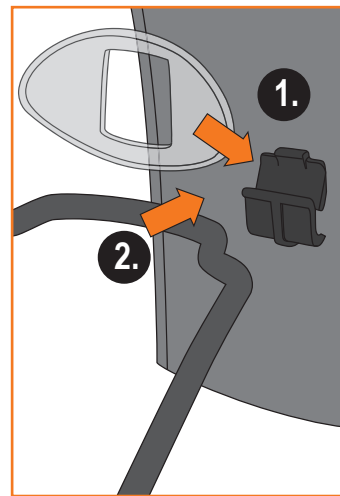
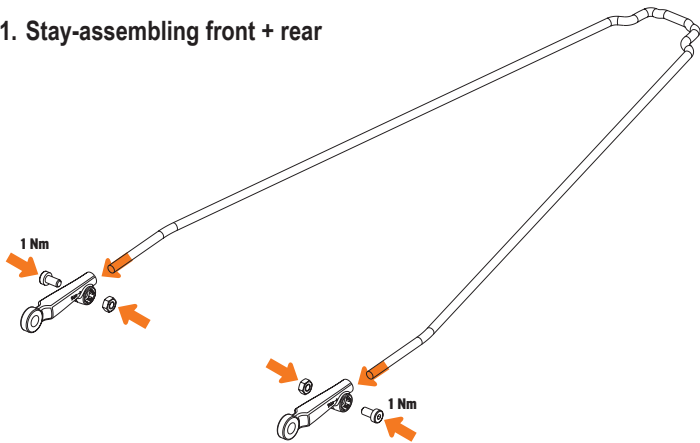

**2. Frame mounting front**

**2.1 Brake-fitting front**

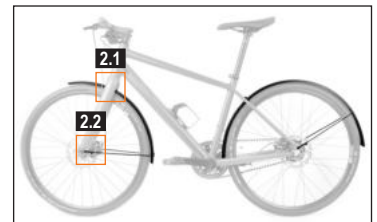
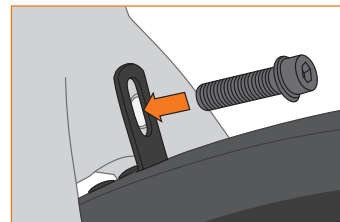

**2.2 Stay attachment front incl. lengths adjustments of the stays**

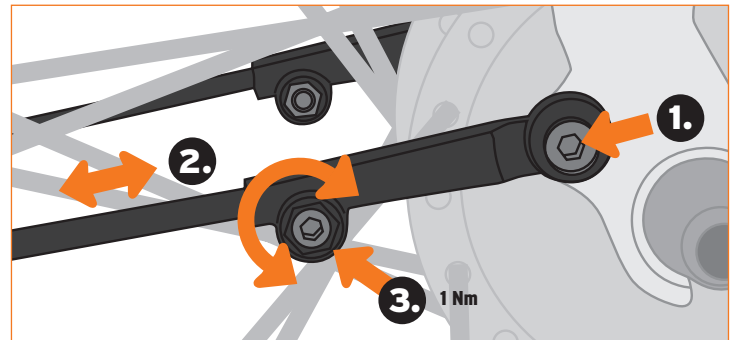

**EN . EDGE AL**

Solid aluminium mudguards in clean look, with rounded edges. Long mudguard profiles ensure maximum protection against splashes.



**3. Frame mounting rear**

**3.1 Remove the rear wheel**

**3.2 Assembling of sliding bridge 90° degree angle**

**3.2.1 Screw the sliding bridge**

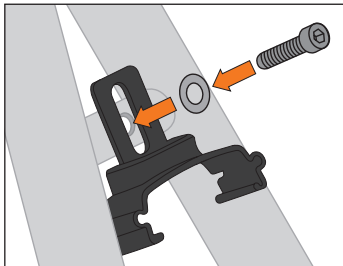

**3.2.2 Clip the fender on the sliding bridge**

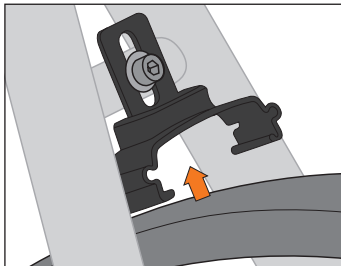

**3.3 Assembling of sliding bridge 0° degree angle**

**3.3.1 Screw the sliding bridge**

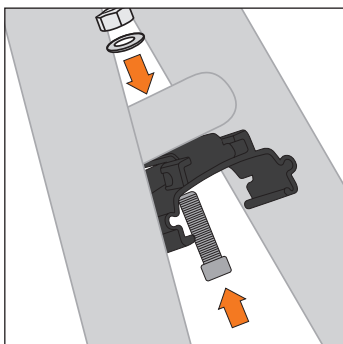

**3.3.2 Clip the fender on the sliding bridge**

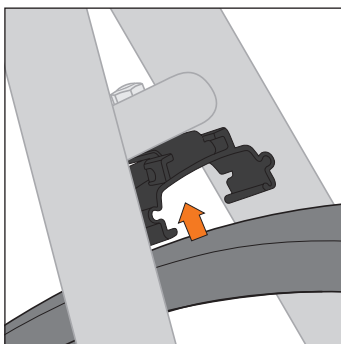

**4. Assembling at the bottom bracket**

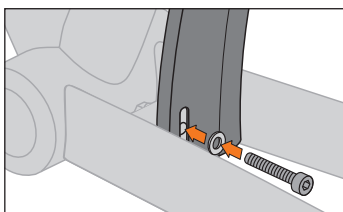

**5. Remount the rear wheel**

**6. Rear stay assembling**

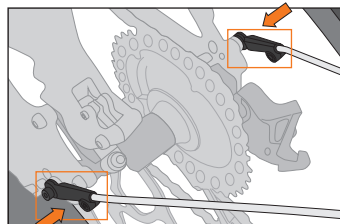

**6.1 Stay attachment rear incl. lengths adjustments of the stays**

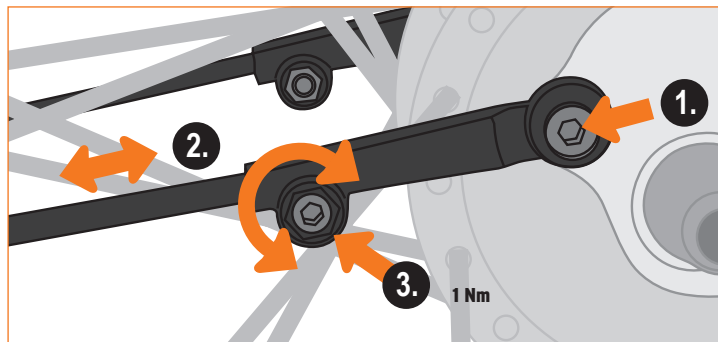

**ATTENTION!** Mounting of spacers for frames with disc brakes

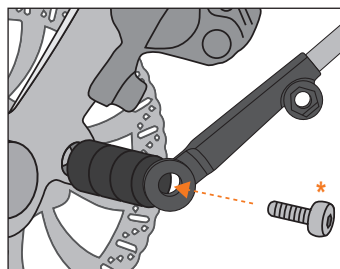

\* Screw is not included in the scope of delivery

PROFILE WIDTH	PART NO.	TYRES	LENGTH FRONT	LENGTH REAR
56 mm	11530	700 x 38c - 50c	740 mm	1200 mm

**ACCESSORIES:**



**11259** Suspension fork mounts for Rock Shox and Suntour



**11260** Suspension fork mounts for Rock Shox and Suntour, angled